

OPERATION AND MAINTENANCE SHEET FOR 5-52001 JACK KIT, HYDRAULIC HAND - 4 TON

Hand Pump 5-52005
Standard Ram 5-52006

MODEL
5-52001

Repair Kits
Hand Pump 5-570
Ram 5-571

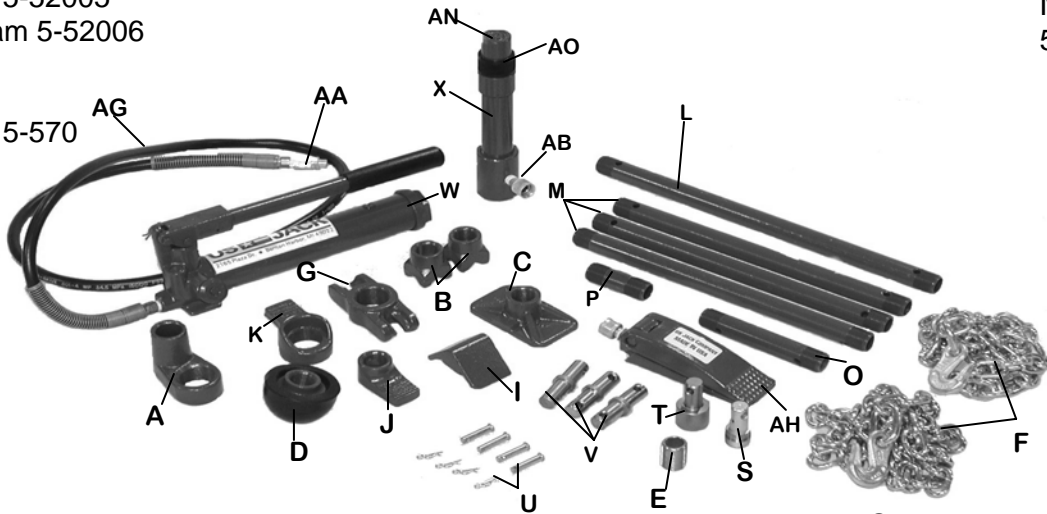

INTRODUCTION

| DESCRIPTION | | PART # | NEED |
|-------------------------------|-------|----------|------|
| Clamp (Offset) Head (one) | A | 13-11620 | 1 |
| 90° Concave "V" Base | B | 13-11626 | 2 |
| Flat Base | C | 13-11625 | 1 |
| 3" Rubber Head Assembly | D | 4-50577 | 1 |
| 3" Rubber Head Only NOT | SHOWN | 13-11639 | 1 |
| Male Connector | E | 10-11644 | 1 |
| Chain & Hook | F | 10-11694 | 2 |
| Chain Pull Plate | G | 13-11627 | 1 |
| Wedge Head | I | 13-11617 | 1 |
| Plunger Toe | J | 13-11618 | 1 |
| Body Toe | K | 13-11619 | 1 |
| 18" Extension Tube | L | 13-11633 | 1 |
| 15" Extension Tube | M | 13-11632 | 3 |
| 6" Extension Tube | O | 13-11630 | 1 |
| 3" Extension Tube | P | 13-11629 | 1 |
| Male Adaptor | S | 13-11634 | 1 |
| Female Adaptor | T | 13-11635 | 1 |
| Lock Pins | U | 58451 | 4 |
| Ext Tube Connectors | V | 13-11636 | 3 |
| Pump | W | 5-52005 | 1 |
| Standard Ram | X | 5-52006 | 1 |
| Quick Disconnect (Hose & Ram) | Z | 19-11812 | 1 |
| Coupler Hose Half | AA | 19-11811 | 1 |
| Coupler Ram Half | AB | 19-11810 | 1 |
| Hose | AG | 13-11695 | 1 |
| *OPTIONAL Hyd. Mini | AH | 5-52047 | 1 |
| Ram Caps | AN | 13-11678 | 1 |
| Thread Protectors | AO | 2-53329 | 1 |

The power unit is a combination of a pump, ram hose and coupler. The release valve is conveniently located near the pump plunger and is controlled by hand to release or diminish the hydraulic power. The pump also contains an automatic safety valve which protects the ram from overload damage. The high pressure hose is reinforced internally with steel wire to insure maximum safety. The ram half and the hose half of the quick coupler provide a fast and positive connection when firmly tightened by hand. Ram travel is limited by means of a positive ram stop to further protect your equipment. Versatility of the unit is extended considerably with a broad assortment of attachments.

Should any adjustments beyond simple maintenance be required, we recommend that you contact the Factory Authorized Service Center nearest you.

This equipment complies with OSHA Standards, where applicable.

CAUTION:

A box-end or socket wrench must be used when assembling the ram half of the quick coupler to the ram. The coupler may be damaged beyond repair by using an open-end wrench. It is also recommended that Teflon Tape be used on all pipe threads.

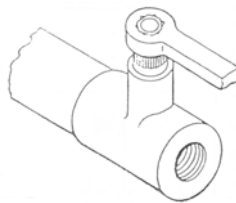

Be sure to use a dust cap to protect against dirt entering ram half of coupler when ram is disconnected from hose.

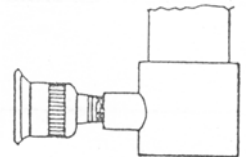

ATTACHMENTS: The attachments shall safely withstand direct (concentric) loads of 4,000 lbs, and indirect (offset) loads of 1,600 pounds per Government specs A-A-314.

MAINTENANCE:

AIRBOUND— If the pump misses strokes and the ram operates erratically, it has become airbound. This can occur during shipment or by leaving the release valve open for an extended period of time. To eliminate airbind, position the pump horizontally, or vertically with the hose end down, and locate the ram lower than the pump. Then fully extend and retract the ram two or three times.

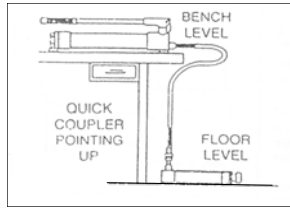

REFILLING— If the above problem is not corrected with the procedure described, the pump may require additional oil. Refill the pump as follows: (1) position the pump horizontally, (2) fully retract the ram, (3) remove the filler screw, (4) add oil until level with the bottom of the hole, (5) close release, (6) pump the ram out fully and retract it to bleed the line of air. (see above section—AIRBIND) and (7) recheck the oil level and replace the filler screw.

On 4 ton pumps the filler screw is located on the side of the oil cylinder

CAUTION— No hydraulic brake fluid nor any fluid with an alcohol base should be used when refilling.

AVOID OVERLOADING THE RAM— Know the capacity of your ram and never exceed it. A broken cup, bent plunger or cracked cylinder may result from overloading.

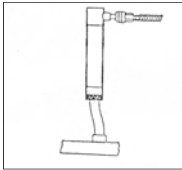

AVOID EXCESSIVE OFF-CENTER LOADS—

Off-center loads can not be avoided when using to lift. Whenever employing any of these attachments, carefully observe the effect with incremental increases of force.

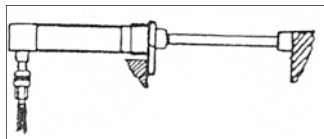

CAUTION: Since off-center loads contribute additional strain on the ram plunger and dual lock extensions, excessive off-center loads must be avoided. If pumping becomes abnormally difficult, stop immediately and check alignment.

AVOID OVER EXTENDING THE RAM— Be careful to avoid over extending the plunger. It is possible to force the plunger out of the ram due to the enormous hydraulic power available.

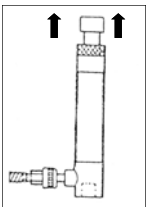

AVOID DROPPING HEAVY OBJECTS ON THE HOSE—

Heavy objects dropped on the hose will likely weaken the hose at the point of impact. Internal wires, which strengthen the hose will tend to bend at this point and eventually break. Avoid carrying the hydraulic pump by the hose. Also avoid sharp kinks in the hydraulic hose. Never apply pressure when the hose is swung in sharp curves. Your hydraulic hose will last longer with proper care.

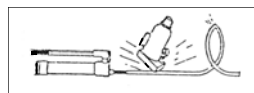

AVOID STRIPPING THREADS— Any time threads at the top of the ram plunger or on the ram cylinder are not connected, protect them with a head attachment or protector ring. If threads become damaged, carefully file them until an exact fit is obtained.

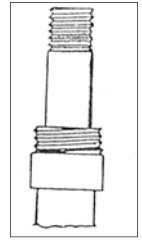

AVOID CROWDING—Provide adequate

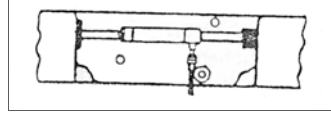

clearance for the hose and quick coupler to avoid unexpected crowding when the ram is extended. Keep clear of obstructions whenever possible.

AVOID CLOGGED OIL LINES— Whenever disconnecting the quick coupler, always thread dust caps over the open connections. Always clean the hose and end of the coupler before inserting it into the ram portion. This will help guard against the entrance of dirt and foreign matter into the pressure line and prevent possible failure of the hydraulic pump and ram packing.

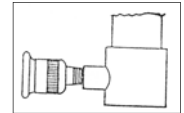

AVOID THE PROXIMITY OF HEAT—Excessive heat contributes to soft packings, oil leakage and rapid deterioration of the hose.

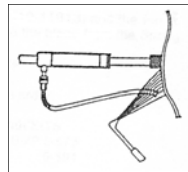

GENERAL INSTRUCTIONS

To assure long and dependable performance of your hydraulic tools, the following precautions should be observed:

1. Be sure that all units are wiped clean before and after using. A light grade of oil should be used on moving parts to prevent rusting and prolong life.
2. Load should be centered before applying pressure to prevent bending ram from side strain.
3. Make sure that all attachments are fully tightened.
4. When not in use, ram and pump piston should be fully retracted and release valve closed. Connecting openings to tools should be plugged to prevent entrance of foreign matter.
5. Refill only with recommended hydraulic jack oil.

OPERATING INSTRUCTIONS

Attach hose from pump to ram and position as shown in illustration. Ram may be in either a horizontal or vertical position with connection up. Pump must be above level of ram as shown. Pump ram to fully extended position and release. Close release when ram is fully retracted and units are ready for use. Spreader should be positioned with connection up.

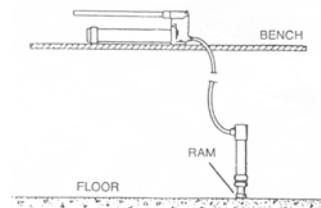

FAILURE TO OPERATE

There are times when one or more simple conditions exist that could prevent satisfactory operation of your power tools.

1. **Airbound**—Extend and retract ram several times as shown under operating instructions.
2. **Will not hold load**—(a) Release may not be tight enough. (b) Packing may be damaged and need replacing.
3. **Foreign matter** under valve balls or valves sticking - See Airbound. If this action does not correct condition, oil should be drained, unit flushed with kerosene, and refilled. Valve balls and seats should be examined for defects.
4. **Leakage**—Tighten packing nut at pump piston if leaking. Replace "U" packing set if leak continues. On rams replace seals using repair kit. (5-571)

HOOK-UP ASSEMBLY

For maximum safety always use lock pins with adapters and connectors. During assembly be sure to fully hand tighten all connections. Attachments may be threaded to the top of the plunger or to the top or bottom of the ram cylinder. When using extensions, locate a tube connectors between two extensions or locate an adapter (male or female as required) between an extension and the ram.

CAUTION—Using any fitting other than high-pressure forged fittings especially designed to withstand the hydraulic pressures involved is extremely hazardous.

WARNING

- A. THIS DEVICE IS A LIFTING DEVICE ONLY. THE LOAD SHALL BE SUPPORTED IMMEDIATELY BY OTHER APPROPRIATE MEANS.
- B. DO NOT OVERLOAD. OVERLOADING CAN CAUSE DAMAGE TO OR FAILURE OF THE JACK.
- C. LIFT ONLY ON AREAS OF THE VEHICLE AS SPECIFIED BY THE VEHICLE MANUFACTURER
- D. THIS JACK IS DESIGNED FOR USE ONLY ON HARD, LEVEL SURFACES CAPABLE OF SUSTAINING THE LOAD. USE ON OTHER THAN HARD, LEVEL SURFACES CAN RESULT IN JACK INSTABILITY AND POSSIBLE LOSS OF LOAD.
- E. FAILURE TO HEED THESE WARNINGS MAY RESULT IN LOSS OF LOAD RESULT IN LOSS OF LOAD, DAMAGE TO THE JACK, AND/OR FAILURE RESULTING IN PERSONAL INJURY OR PROPERTY DAMAGE.

STANDARD RAM 5-52006

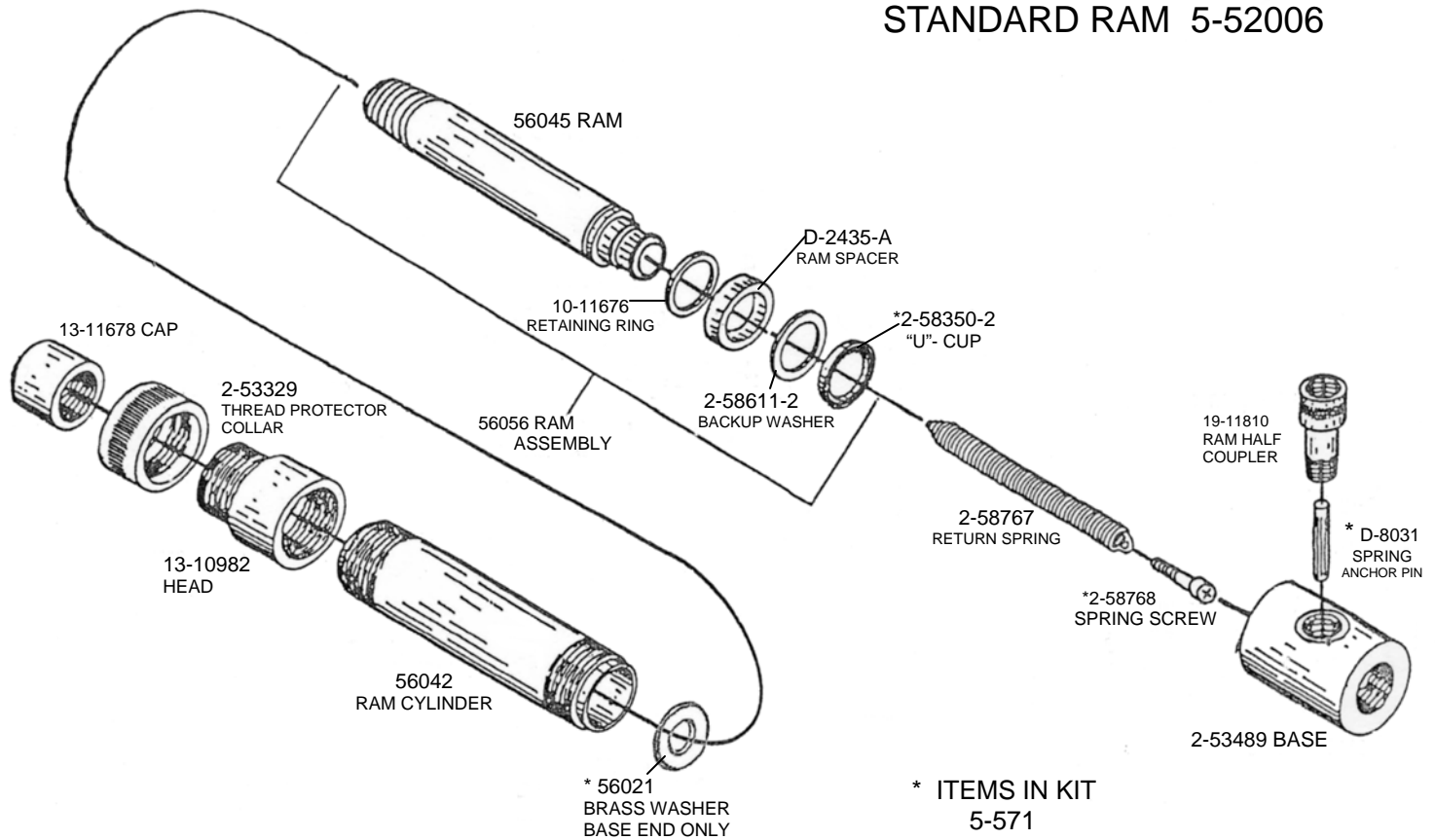

HAND PUMP 4 TON 5-52005

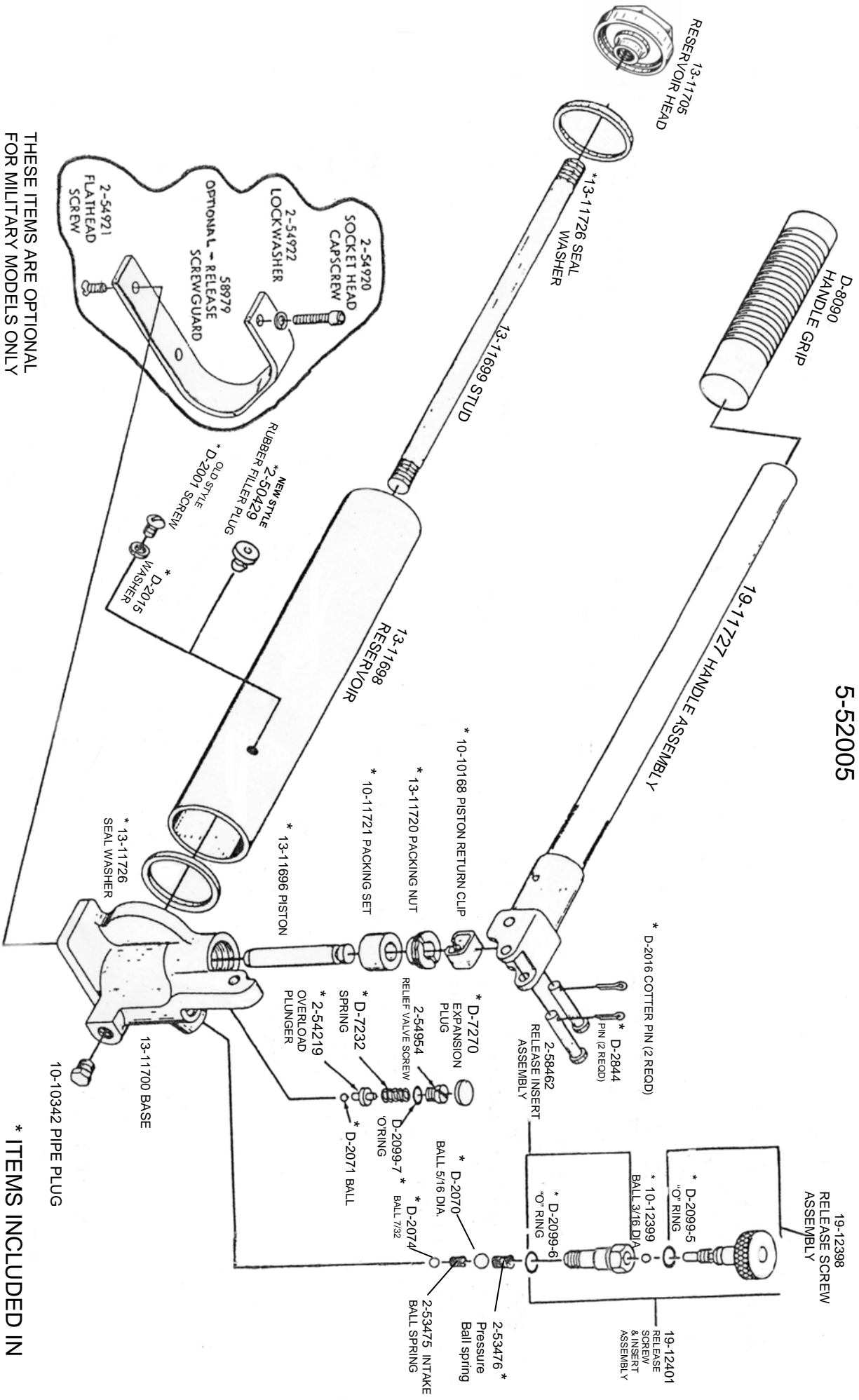

THESE ITEMS ARE OPTIONAL FOR MILITARY MODELS ONLY

* ITEMS INCLUDED IN SEAL KIT 5-570